

PCE Americas Inc.  
711 Commerce Way  
Suite 8  
Jupiter  
FL-33458  
USA  
From outside US: +1  
Tel: (561) 320-9162  
Fax: (561) 320-9176  
info@pce-americas.com

PCE Instruments UK Ltd.  
Units 12/13  
Southpoint Business Park  
Ensign way  
Hampshire / Southampton  
United Kingdom, SO31 4RF  
From outside UK: +44  
Tel: (0) 2380 98703 0  
Fax: (0) 2380 98703 9  
info@pce-instruments.com

[www.pce-instruments.com/english](http://www.pce-instruments.com/english)  
[www.pce-instruments.com](http://www.pce-instruments.com)

## Manual Force Gauge PCE-CS 1000 N



Version 1.0  
26.08.2014

Table of contents

<b>1</b>	<b><i>Introduction</i></b> .....	<b>3</b>
<b>2</b>	<b><i>Safety precautions</i></b> .....	<b>3</b>
<b>3</b>	<b><i>Specifications</i></b> .....	<b>6</b>
3.1	Delivery content and assembly .....	7
<b>4</b>	<b><i>Equipment description</i></b> .....	<b>7</b>
4.1	Measuring equipment .....	7
4.2	Remote control.....	8
<b>5</b>	<b><i>Operating Instructions</i></b> .....	<b>9</b>
5.1	Switching on / off.....	9
5.2	Zero.....	9
5.3	Tare.....	9
5.4	Save value .....	9
5.5	Change measuring unit.....	9
<b>6</b>	<b><i>Equipments settings</i></b> .....	<b>10</b>
6.1	“oFF” Set automatic switch-off .....	10
6.2	“br 3” Set background lighting .....	10
6.3	“IdL” Lighting duration” .....	10
<b>7</b>	<b><i>Troubleshooting</i></b> .....	<b>10</b>
<b>8</b>	<b><i>Custom settings</i></b> .....	<b>11</b>
8.1	Equipment configuration .....	11
8.1.1	Change resolution .....	11
8.1.2	Automatic zero tolerance.....	11
8.1.3	manual zero tolerance.....	11
8.1.4	zero tracking range tolerance .....	11
8.1.5	not explained function .....	11
8.1.6	Zero setting.....	11
8.1.7	Setting measuring interval .....	12
8.1.8	Setting dynamic weighing.....	12
8.1.9	Setting gravity .....	12
8.1.10	Setting user unit .....	12
8.2	Calibration.....	13
8.2.1	Calibration gravity .....	13
8.2.2	Max. Capacity .....	13
8.2.3	Linear calibration.....	14
<b>9</b>	<b><i>Disposal</i></b> .....	<b>15</b>

## 1 Introduction

The crane scale carries out internal weight checks. The crane scales power is supplied via the 3 x AA batteries, which have an operating time of up to 65 hours. The crane scale has a maximum load range of 1.000kg. A hook, a shackle and a remote control are included in the delivery content.

## 2 Safety precautions

- Before installing and putting this equipment into operation, please read the operating instructions through carefully. We are not liable for damages that occur due to non observance of the operating instructions.
- If the equipment is not used for a long period of time, then remove the batteries.
- In order to prevent potential hazardous situations when using this measuring equipment, it is vital to adhere to the safety precautions provided by the manufacturer.
- Do not expose the equipment to extreme temperatures, direct sunlight, extreme humidity or moisture
- Never use the measuring equipment with wet hands.
- It is not permitted to carry out any technical changes on the equipment.
- The equipment should only be cleaned with a damp cloth. Do not use abrasive cleaners or detergents which contain solvents.
- The equipment must only be used with accessories offered by PCE Germany or with replacements of equal value.
- The environmental conditions, for example the temperature ranges in which the measuring equipment can be used, as stipulated in the operating instructions specifications, must always be adhered to. Otherwise the operation of the equipment is prohibited.
- The measuring equipment is not to be used in an environment where there is a danger of explosion.
- Do not measure more than a ton.
- In order to prevent potential hazardous situations when using heavy-lifting equipment, it is vital the manufacturer and the operator adhere to certain requirements. When using the measuring equipment, no risk must be posed to the operator.
- The operator or the person responsible for operating the measuring equipment must adhere to the national regulations for example health and safety at work regulations or any other governmental safety standards.
- There are also other safety precautions to be taken into consideration when operating the equipment, for example precautions provided by the crane, lifting device or shackle manufacturer etc.
- The assembly, the commissioning and the servicing of the measuring equipment must only be carried out by properly trained personnel who have been provided with the appropriate protective equipment.
- The measuring equipment must not be altered and is only allowed to be used for the intended purpose.
- The measuring equipment as well as any other equipment (for example the crane or any other heavy-lifting equipment) must be regularly serviced and maintained and where necessary have the service history correctly logged or certified. Each time before using the equipment a visual check must be carried out. In the case of any discrepancies for example cracks, breaks or deformities, the equipment must be immediately disabled and declared unfit for use. This must also be reported where necessary to the person in your company who is responsible for health and safety.
- Repairs must only be carried out by trained service personnel and only approved replacement parts must be used when carrying out a repair. All repairs, servicing and replacement parts must be documented by the service department
- The operating instructions as well as the safety instructions must always be visible whilst using the measuring equipment.
- The measuring equipment is **not explosion-proof** and must not be used in an environment where there is a danger of explosion. The environmental conditions, for example the temperature

ranges in which the measuring equipment can be used, as stipulated in the operating instructions, must always be adhered to. The usage of the equipment in areas which are exposed to high levels of contamination or corrosion should be avoided. In instances of major temperature fluctuations, the equipment must be given time to acclimatise before being used.

- The measuring equipment is only to be used for lifting and weighing of freely moving loads. A twisting or stressing of the load must not occur during the weighing process. The equipment must not be used for lifting people. It is prohibited for loads to be allowed to be dropped or be pulled along the ground or pulled at an angle.
- The maximum load as stipulated in the operating instructions [MAX] must never be exceeded (this also includes the maximum load stipulated for the crane or the heavy-lifting equipment being used in conjunction with the measuring equipment).
- Whilst operating the equipment any other potential hazardous areas, directly around the equipment should also be taken into consideration. When the equipment is in operation the hazardous area must be kept clear of any personnel. Directly beneath the load is of course an obvious hazardous area, but the danger of, for example a cable snapping, should also be taken into consideration, and a sufficient amount of safety distance should be observed.

If you have any questions, please contact PCE Instruments UK Ltd



**Servicing and examination**

**Checks to be made before the use of the measuring equipment**

The equipment must be checked before the beginning of every workday. . In the course of the examination, the operator must ensure that,

- no deformations or other damages for example cracks are visible
- all the attachment parts are present and in good order and condition (for example safety splints etc.).
- the present complete system does not conceal any hazards (for example an incorrect assembly).
- there are no potential hazards within the vicinity of the operating area and if so the must be dealt with or rendered safe before operating the equipment.

**Regular inspection / Servicing**

After every 3 months or after 12,500 measurements, depending on which comes first.	<ul style="list-style-type: none"><li>- Check all parts for any excessive wear and tear.</li><li>- Check all dimensions.</li><li>- Check housing for any signs of deformation or damage.</li><li>- Check all parts and ensure they are functioning correctly.</li></ul>
After every 12 months or after 50,000 measurements, depending on which comes first.	<ul style="list-style-type: none"><li>- Check all load-bearing parts for example hairline cracks etc. Only trained personnel are to carry out maintenance.</li></ul>
After every 5 years or 25,000 measurements, depending on which comes first.	<ul style="list-style-type: none"><li>- All load-bearing parts must be exchanged.</li></ul>
After every 10 years or 50,000 measurements, depending on which comes first.	<ul style="list-style-type: none"><li>- If the measuring equipment has reached the end of its usable life, then it needs to be replaced.</li></ul>

If property damage and personal injury is caused through incorrect use or non compliance of the regulations then the owner or the operator is responsible. The manufacturer will not be liable for damages caused by inappropriate handling. The safety guidelines are an excerpt out of the applicable standards and regulations, including suggestions and tips. These do not replace the valid standards and regulations, but are there to ensure a safe usage of the measuring equipment. You should familiarise yourself with the valid national safety and regulations.

If you have any questions, please contact PCE Instruments UK Ltd

### 3 Specifications

Technical Data	
Measuring range	1.000 kg
Resolution	200 g
Minimum load	10 kg
Measurement error	± 1% of the measuring range
Tare range	100 % F.s.
Response time	≥ 1 second
Safety load	150 % (On no account may this be exceeded)
Display	LCD with background lighting
Digit height	20 mm
Ambient temperature	-10°C ~ +40°C
Power supply	3 x 1,5 V AA-Battery (operating time up to 65 h)
Weight	approximately 1,4 kg including batteries / hook and shackles

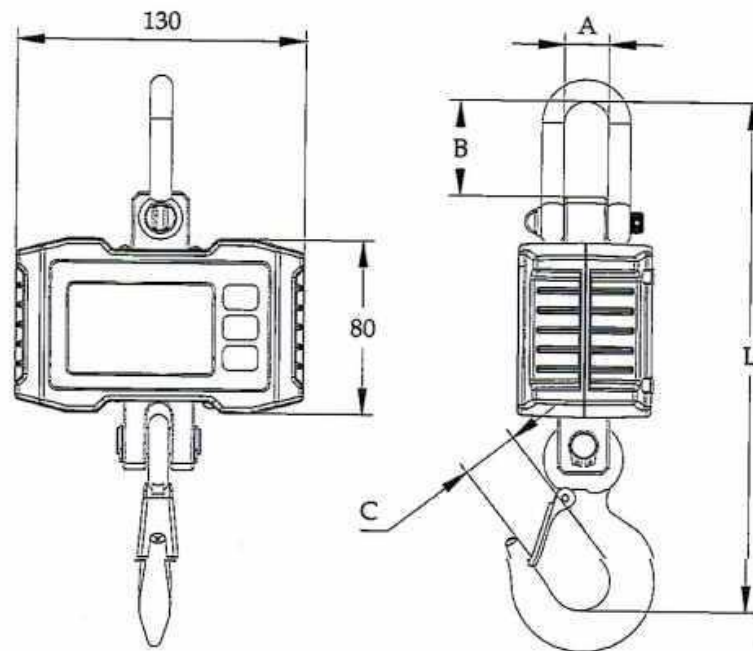

Model	A	B	C	L
PCE-CS 1000N	20mm	43mm	27mm	230mm

### 3.1 Delivery content and assembly

1 x PCE-CS 1000N / 5 x 1,5 V AA-Batteries / 1 x remote control / 1 x operating instructions

## 4 Equipment description

### 4.1 Measuring equipment

4-1 "Power" button

4-2 Infrared sensor

4-3 Display

4-4 "Tare/Zero" button

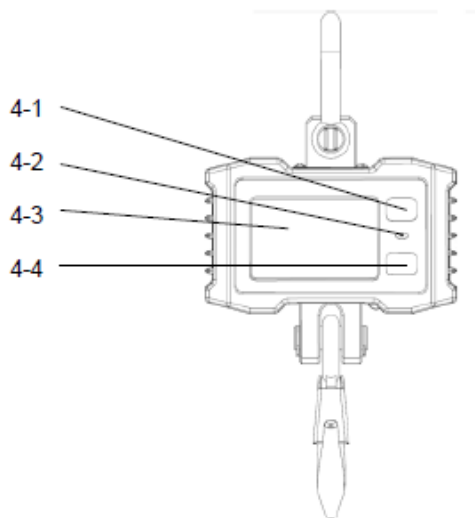

Display	<ul style="list-style-type: none"> <li>Shows the measured values</li> </ul>
Power button	<ul style="list-style-type: none"> <li>Turns the equipment on and off</li> </ul>
Infrared sensor	<ul style="list-style-type: none"> <li>Sensor for the remote control</li> </ul>
Tare / Zero button	<ul style="list-style-type: none"> <li>To tare or to zero</li> </ul>

## 4.2 Remote control

- 4-1 Upwards / Zero
- 4-2 Hold button / Enter
- 4-3 Downwards
- 4-4 Change unit
- 4-5 Turns the equipment off
- 4-6 Right /Tare
- 4-7 Comma placements
- 4-8 Left
- 4-9 Setup

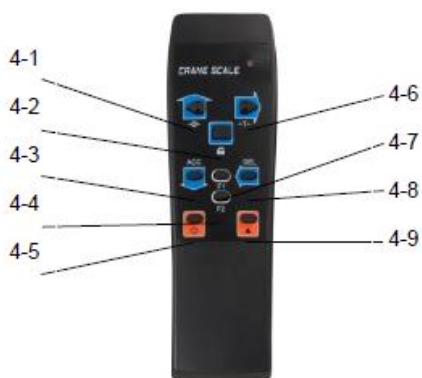

Upwards / Zero	<ul style="list-style-type: none"> <li>• Move one value upwards</li> <li>• Set the measuring value to zero</li> </ul>
Hold button / Enter	<ul style="list-style-type: none"> <li>• Saves the value</li> <li>• Confirms the entry</li> </ul>
Downwards	<ul style="list-style-type: none"> <li>• Moves one position to the right</li> </ul>
Unit change	<ul style="list-style-type: none"> <li>• Changes the unit</li> </ul>
Right /Tare	<ul style="list-style-type: none"> <li>• This takes you one value to the right</li> </ul>
Comma placements	<ul style="list-style-type: none"> <li>• Places a comma</li> </ul>
Left	<ul style="list-style-type: none"> <li>• Takes you one position to the left</li> </ul>
Setup	<ul style="list-style-type: none"> <li>• This takes you to the settings</li> </ul>



## 5 Operating Instructions

### 5.1 Switching on / off

- Press the on / off button until an acoustic signal is emitted. Then “8.8.8.8” appears on the display. The maximum weight is shown “1000.0”. (= 1000 kilograms or 1 ton). The next information shown on the display is the battery value “Bat (Percentage value)”.
- Keep the “On / Off” button pressed now, until the equipment makes an acoustic signal sound. Now let go of the button. The equipment turns itself on. Then the battery value appears on the display. “Bat(percentage value)”. “Off” is then displayed. The equipment switches off.
- The remote control can also be used to switch the equipment off. Press the “Power” button on the remote control.
- The equipment cannot be switched on with the remote control.



### 5.2 Zero

- Press the  button until an acoustic signal sounds. “Z” appears on the display.
- The remote control can also be used to do this. Press “→0←”
- Make sure the value is stable. Otherwise “Err” appears on the display, which means the scale hasn’t been successfully set to zero.

### 5.3 Tare

- Quickly press the  button. “T” appears on the display.
- The remote control can also be used to do this. Press “→T←”
- Make sure the value is stable. Otherwise “Err” appears on the display, which means the scale hasn’t been successfully set to zero.



### 5.4 Save value

- To “freeze” the value on the display, press  on the remote control. The value will then be “frozen”. “H” for HOLD appears on the display.
- To carry on with the measurements, press  again.



### 5.5 Change measuring unit

- Use the remote control to change the measuring unit. Press the “F2” button to choose between the measuring units: “KG” (kilogram), “LB” (Pound) and “UN” (User unit). (UN is explained in point 8.1.10)



## 6 Equipments settings

The remote control is required to get to the equipments setup. Press the “▲” and then press  straight after. “Setup” then appears on the display. You are now in the equipments setup. To access the following functions, you must press .-



### 6.1 “oFF” Set automatic switch-off

- Press . “Off (time)” appears on the display.
- Press “→0←” to set the automatic switch-off time (in minutes). Choose between 0 / 5 / 10 / 15 / 30 / 60 minutes.
- To save the settings, press  until “End” appears on the display.

### 6.2 “br 3” Set background lighting

- To set the background lighting, press  twice. “br (Illuminance)” appears on the display.
- Now press →0← to set the lighting. Choose between OFF / 1 / 2 and 3. The higher the number is, the stronger the lighting becomes
- To save the settings, press  until “End” appears on the display.

### 6.3 “IdL” Lighting duration”

- To set the lighting duration, press  three times. “Idl (lighting duration)” appears on the display.
- Press the →T← to set the lighting. You can set it on to 0, 5, 10, 15, 30 and 60. These values are seconds. Press  until “End” appears on the display to save the settings.

## 7 Troubleshooting

Symptom	Cause	Solution
Equipment won't switch on.	The battery is empty or is damaged.	Change the batteries. The scale won't go on, if the voltage is under 3,2 V.
Background lighting is flashing.	The battery is nearly empty.	Change the batteries.
The buttons do not function.	The buttons are faulty.	Return the equipment for repair.
Readout does not remain stable	The equipment is faulty.	Return the equipment for repair.
	The item being weighed is moving or not steady.	Stabilize the item.
“Err” appears on display whilst taring and zero setting	The item being weighed is moving or not steady. The value is not stable.	Stabilize the item being weighed.

## 8 Custom settings



Important: The following setting options should only be carried out by a suitably trained operator. Incorrect settings can make the scale unusable. The remote control is required to get to the custom settings. Press the "▲" button twice. "P0000" appears on the display. The codes for the individual sections are to be

entered here with help of the blue arrow button on the remote control. Confirm the code with .



### 8.1 Equipment configuration

- The code for this configuration is "0258".
- Confirm the code with . Scale is displayed.

#### 8.1.1 Change resolution

- Press  again. "E (resolution)" is displayed.
- The resolution can be changed with the arrow buttons on the remote control.
- To save the settings, press  until "End" appears on the display.

#### 8.1.2 Automatic zero tolerance

- To set the automatic zero tolerance, press  twice. "A (percent value)" is displayed.
- The tolerance can be changed with the arrow buttons on the remote control. Choose between 0 (switched off), 2(±2% FS), 3(±3% FS), 4 (±4% FS), 10 (±10% FS), 20 (±20% FS) and 100 (±100% FS)-
- To save the settings, press  until "End" appears on the display.

#### 8.1.3 Manual zero tolerance

- Press  three times (percentage value)" is displayed. This function is not explained



#### 8.1.4 Zero coverage area tolerance

- Press  four times (percentage value)" is displayed. This function is not explained



#### 8.1.5 Not explained function

- Press  five times (percentage value)" is displayed. This function is not explained

#### 8.1.6 Zero setting



- To turn the Zero setting on and off, press  six times. "5 (on/off)".
- This function can be activated (on) or deactivated (off) with the arrow buttons "up" and "down".
- To save the settings, press  until "End" appears on the display.

### 8.1.7 Setting measuring interval



- To set the stability strength, press  seven times. “Stb (strength)” is displayed.
- The strength can be changed with the remote control. Choose between 0 (switched off), 1 (weakest), 2 (weak), 3 (normal), 4 (strong), 5 (strongest).
- To save the settings, press  until “End” appears on the display.

### 8.1.8 Setting dynamic weighing

If you need a quick indication of weight, but accuracy isn't necessarily important, then this is the function that could be advantageous for you.

- To turn the “dynamic weighing” function on and off, press  eight times. “dy(on/off)” is displayed.
- This function can be activated (on) or deactivated (off) with the arrow buttons “up” and “down”.
- To save the settings, press  until “End” appears on the display.

### 8.1.9 Setting gravity

- To set the gravity, press  nine times. (value) is displayed.
- The value can be changed with the “up” and “down” buttons. The lowest value is 0.000 and the highest is 9.999. 9.794 is the average value.
- To save the settings, press  until “End” appears on the display.

### 8.1.10 Setting user unit



The weight can be converted into a different information. Example: A cable reel weighs 785,5 kg, how many metres of cable are on the reel? You can provide the scale with a conversion factor that converts the weight. You can switch between the weight reading and the user unit “U”.

- To change the user unit, press  10 times. U (value) is displayed.
- With the arrow buttons on the remote control, values can be chosen between 0.000 and 9999. To be able to use this function, the measuring unit has to be changed to “UN” whilst the weight measurement. The user unit is dependent on kilogram.

- 

## 8.2 Calibration



If the scale is giving incorrect readings, it is possible to re-adjust them. The scale will permit the resetting or adjustment of the gravitational force. If the correct factor is entered, the scale will give an accurate weight reading. Should the correct gravitational force factor have already been entered and the scale is still giving incorrect readings, then the scale can be adjusted by up to three calibration points. Therefore there is also the option to carry out a 1 point / 2 point or even a 3 point adjustment. However if only one calibration weight is available, then the re-calibration can be concluded after the first calibration point. We suggest you to use  $\frac{3}{4}$  of the load for the 1 point calibration and for the 3 point calibration, for example  $\frac{1}{3}$ ,  $\frac{2}{3}$  or the full load. The individual adjustment points can be freely set on the scale and can be adapted to the weights provided by the operator.

- The code for the configuration is "8416"
- Confirm the code by pressing . "CAL" is displayed.
- Now press . "Un (KG/LB)" is displayed.
- Choose between KG (kg) and Lb (lb) with the arrow buttons "up" and "down"

### 8.2.1 Calibration gravity















- To change the calibration gravity press  "G (value)" is displayed.
- The value can be changed with the arrow buttons on the remote control. Choose between 0.000 and 9999. The default value is 9.794. The average value in Germany is 9.810.

### 8.2.2 Max. Capacity

- To change the max. capacity, press  again. 5 numbers will be displayed.
- The value can be changed with the arrow buttons on the remote control. Choose between 0.0000 and 99999. The default value is 01000. **Do not exceed the maximum value of one ton!!!**
- To save the settings, press  until "End" appears on the display.

### 8.2.3 Linear calibration

Three different weights with large weight size differences should be used for the calibration. The scale must hang freely whilst measuring.

- To change the linear calibration, press  again. "LoAd0" is displayed.
- Press  to start the measurement.
- Wait until the measurement is stable.
- Press  again. "LoAd1" appears on the display
- Press  repeatedly. The display shows 00000. With the arrow buttons, enter the weight which you will hang on the scale first. If you press the F1 button then you can also set low values.
- Confirm your entry by pressing .
- Wait until your measurement is stable.
- Press  again. "LoAd2" appears on the display
- If this value is sufficient, then switch the equipment off or press  to continue.
- Press  repeatedly. 00000 appears on the display.
- The second measuring unit can be entered with the arrow buttons. Also hang the second measuring unit on the scale. With F1 small entries can also be entered.
- Press  and wait for the value to become stable.
- Press . "LoAd3" is displayed.
- If this entry is enough, then switch the equipment off or press  to carry on.
- Press  repeatedly. The display shows 00000.
- The third measuring unit can also be entered with the arrow buttons. Also hang the third measuring unit on the scale. With F1 small entries can also be entered.
- Press  and a further measurement will be carried out.
- Wait for the reading to stabilize and then press  and the calibration has now been completed.

## 9 Disposal

### NOTE according to Battery regulations (BattV)°

Batteries must not be disposed of in household waste. The end user is legally obliged to return. Used batteries can be returned to disposal authorities or to PCE Germany GmbH.

### Receiving office BattV

PCE Deutschland GmbH  
Im Langel 4  
59872 Meschede

To comply with ElektroG (Rücknahme und Entsorgung von Elektro- und Elektronikgeräten) our equipment can be returned. We will either re-use the equipment or it will be disposed of by a recycling company according to legal requirements.

If you have any questions, please contact PCE Instruments UK Ltd

To comply with ElektroG (Rücknahme und Entsorgung von Elektro- und Elektronikgeräten) our equipment can be returned. We will either re-use the equipment or it will be disposed of by a recycling company according to legal requirements.



Alle PCE-Produkte sind CE  
und RoHS zugelassen.

WEEE-Reg.-Nr. DE6927812